



Высокоскоростные термопечатающие механизмы FTP-632MCL353, FTP-632MCL354

Технические характеристики

Архангельск (8182)63-90-72	Ижевск (3412)26-03-58	Магнитогорск (3519)55-03-13	Пермь (342)205-81-47	Сургут (3462)77-98-35
Астана (7172)727-132	Иркутск (395)279-98-46	Москва (495)268-04-70	Ростов-на-Дону (863)308-18-15	Тверь (4822)63-31-35
Астрахань (8512)99-46-04	Казань (843)206-01-48	Мурманск (8152)59-64-93	Рязань (4912)46-61-64	Томск (3822)98-41-53
Барнаул (3852)73-04-60	Калининград (4012)72-03-81	Набережные Челны (8552)20-53-41	Самара (846)206-03-16	Тула (4872)74-02-29
Белгород (4722)40-23-64	Калуга (4842)92-23-67	Нижний Новгород (831)429-08-12	Санкт-Петербург (812)309-46-40	Тюмень (3452)66-21-18
Брянск (4832)59-03-52	Кемерово (3842)65-04-62	Новокузнецк (3843)20-46-81	Саратов (845)249-38-78	Ульяновск (8422)24-23-59
Владивосток (423)249-28-31	Киров (8332)68-02-04	Новосибирск (383)227-86-73	Севастополь (8692)22-31-93	Уфа (347)229-48-12
Волгоград (844)278-03-48	Краснодар (861)203-40-90	Омск (3812)21-46-40	Симферополь (3652)67-13-56	Хабаровск (4212)92-98-04
Вологда (8172)26-41-59	Красноярск (391)204-63-61	Орел (4862)44-53-42	Смоленск (4812)29-41-54	Челябинск (351)202-03-61
Воронеж (473)204-51-73	Курск (4712)77-13-04	Оренбург (3532)37-68-04	Сочи (862)225-72-31	Череповец (8202)49-02-64
Екатеринбург (343)384-55-89	Липецк (4742)52-20-81	Пенза (8412)22-31-16	Ставрополь (8652)20-65-13	Ярославль (4852)69-52-93
Иваново (4932)77-34-06	Киргизия (996)312-96-26-47	Казахстан (772)734-952-31	Таджикистан (992)427-82-92-69	

Единый адрес для всех регионов: fst@nt-rt.ru || www.fujitsu.nt-rt.ru

24V DRIVE, 2-COLOR THERMAL PRINTER

3" TYPE MECHANISM

FTP-632MCL353/354

■ OVERVIEW

New 2-color printer (blue/black or red/black) joins FTP-602 Series. The series consists of 24V battery drive compact thermal printers which can print at high speed.

This series is suitable as built-in printer for a variety of applications, such as portable terminals, POS terminals, ticket machines, coupon machines, label printers, banking machines, measuring devices, medical equipment, etc.

■ HIGHLIGHTS

- **2 Color printing**
It can print 2 colors: blue/ black or red/black
- **High speed printing**
It can print at 100 mm/s (800 dotlines/s) by using Fujitsu Components' unique head drive control (at monochromatic printing).
Speed of 2-color printing:
 - blue and red: 80 mm/s (460 dotlines/s) maximum
 - monochromatic print: 40mm/s maximum
- **Auto Cutter**
Printer with auto cutter (full cut/ partial cut) is available.
- **Paper auto loading function**
Thermal paper can be loaded without head-up lever operation.
- **Easy head access**
It is designed for easy head cleaning and head replacement.
- **Two paper paths**
Front and bottom paper insertion is available.



FTP-632MCL353

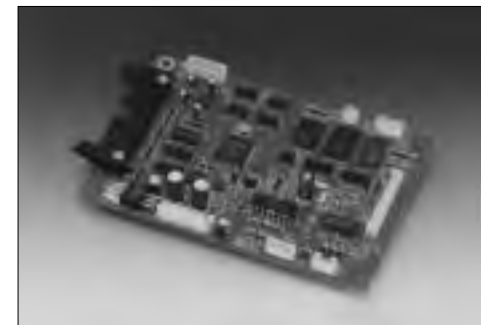

FTP-622DCL/DSL4xx

■ PART NUMBERS

Name		Part Number
Printer Mechanism		FTP-632MCL101 (front paper insertion) FTP-632MCL102 (bottom paper insertion)
Printer Mechanism with Cutter		FTP-632MCL353 (front paper insertion) FTP-632MCL354 (bottom paper insertion)
Interface Board		FTP-622DCL411* ¹ (Centronics standard) FTP-622DSL438* ² (Gothic, Kanji, RS232C standard)
LSI (MCU)		FTP-622CU201* ³
Interface Cable	Parallel (Centronics)	FTP-441Y201
	Serial (RS-232C)	FTP-622Y301
Cable	Power	FTP-622Y401
	Head	FTP-622Y801 (FCC preassembled to mechanism)

*1: FTP-622DCL411 is ANK supported only

*2: FTP-622DSL438 has FLASH memory and can print high speed images

*3: Supports Kanji and parallel and serial interfaces

■ GENERAL SPECIFICATIONS

Item		Specifications	
Part number		FTP-632MCL101/102	FTP-632MCL353/354
Printing method		Thermal-sensitive line dot method	
Dot structure		576 dots/line	
Dot pitch (Horizontal)		0.125 mm (8 dots/mm)—Dot density	
Dot pitch (Vertical)		0.125 mm (8 dots/mm)—Line feed pitch	
Effective printing area		72 mm	
Number of columns		ANK 36 columns (12X24 dot font max.) ANK 48 columns (12X24 dot font max.)	
Paper width		80mm \pm ₁ ⁰ 85mm \pm ₁ ⁰	
Paper thickness		60 to 100 μ m (there may be exceptions)	
Cutting type		---	full or partial
Printing speed		100mm/s (800 dotlines/s maximum at black-white image batch printing)	
Character types		Alphanumeric KANA	:159
		International	:195
		JIS Kanji (Kanji CG loaded board)	:approx. 6800
Character, dimensions(H×W), number of characters	12×24 dots,(1.5×3.0mm)	48 columns	
	24×24 dots,(3.0×3.0mm)	28 columns	
	8×16 dots,(1.0×2.0mm)	72 columns	
	16×16 dots,(2.0×2.0mm)	36 columns	
Interface		Centronics / RS-232C standard	

(Continued)

Item		Specifications	
Part number		FTP-632MCL101/102	FTP-632MCL353/354
Power supply	For head	24 VDC \pm 5% 2.3A (24V Rav1500 Ω , 25%printing ratio)	
	For printer motor	24VDC \pm 5% 1A maximum	
	For cutter motor	---	24VDC \pm 5% 1A maximum
	For logic	5VDC \pm 5% 0.5 A maximum	
Dimensions	Printer Mechanism	108 (W) \times 48 (D) \times 20 (H) mm	---
	Mechanism with cutter	---	117 (W) \times 57 (D) \times 38 (H) mm
	Interface board	131 (W) \times 89 (D) \times 24 (H) mm	
Weight	Printer Mechanism	Approximately 94g	---
	Mechanism with cutter	---	Approximately 340g
Life	Head	Pulse durability: 1×10^8 pulse/dot (using Fujitsu Components' standard driving method) Wear resistance: 50 km (at 25% print ratio)	
	Cutter	----	500,000 times minimum
Environmental conditions	Operating temperature	+5 to +40°C (Guarantee, but can operate between 0°C to +50°C)	
	Operating humidity	20 to 85% RH (no condensation)	
	Storage temperature	-20 to +60°C (excluding paper)	
	Storage humidity	5 to 95% RH (no condensation)	
Detection	Head temperature	By thermistor	
	Paper out/Mark detect	By photointerrupter	
	Head release	By slide switch	
Recommended thermal sensitive paper	2 color paper (blue/black) (red/black)	PB770 (Mitsubishi paper) PB670 (Mitsubishi paper)	
	High sensitivity paper	TF50KS-E4 (Nippon paper)	
	Standard paper	TF60KS-E (Nippon paper), FTP-030P0104(80mm) PD150R (Oji paper), FTP-030P0701(80mm)	
	Medium term paper	TP60KS-F1 (Nippon paper), FTP-030P0102(80mm) PD170R (Oji paper) P220VBB-1 (Mitsubishi paper) PD160R-N (Oji paper)	
	Long term paper	AFP-235 (Mitsubishi paper) TP50KJ-R (Nippon paper) HA220AA (Nippon paper)	

FUNCTION

ITEM		ITEM	
1.	Test printing	8.	Motor power save
2.	Paper-out detection	9.	Mark detection
3.	Paper near end detection	10.	MCU trouble detection
4.	Head-up detection	11.	Power on/off sequence protection
5.	Abnormal temp. of thermal head detection	12.	Motor protection
6.	Blown fuse detection	13.	Hardware timer
7.	Abnormal voltage detection of head		

DIMENSIONS

1. Printer mechanism

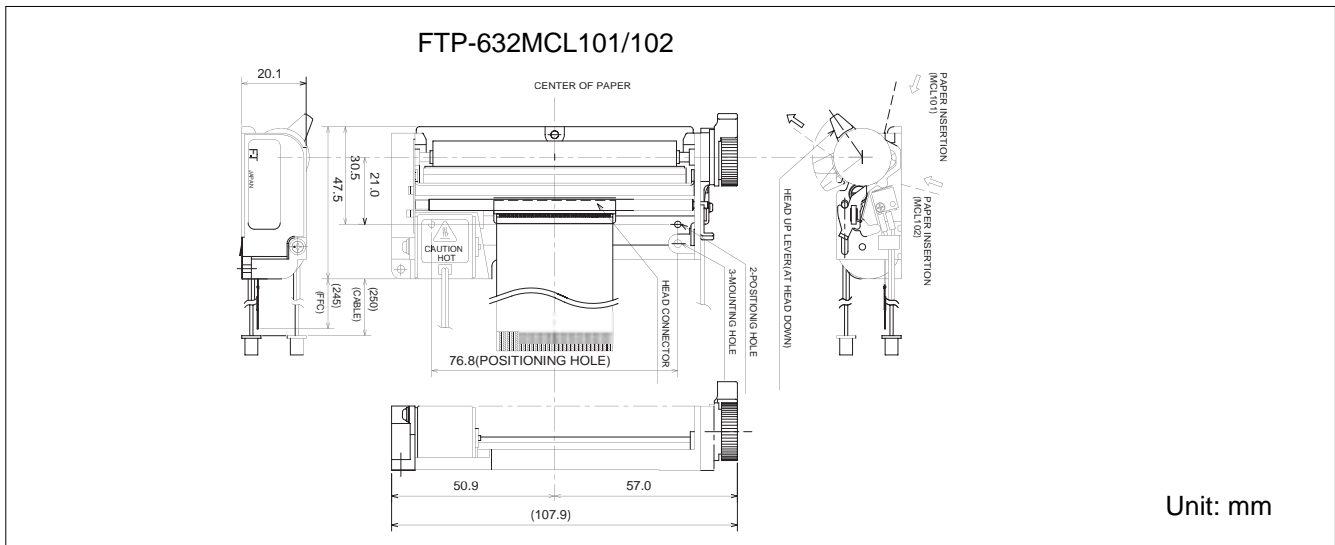

2. Printer mechanism with cutter

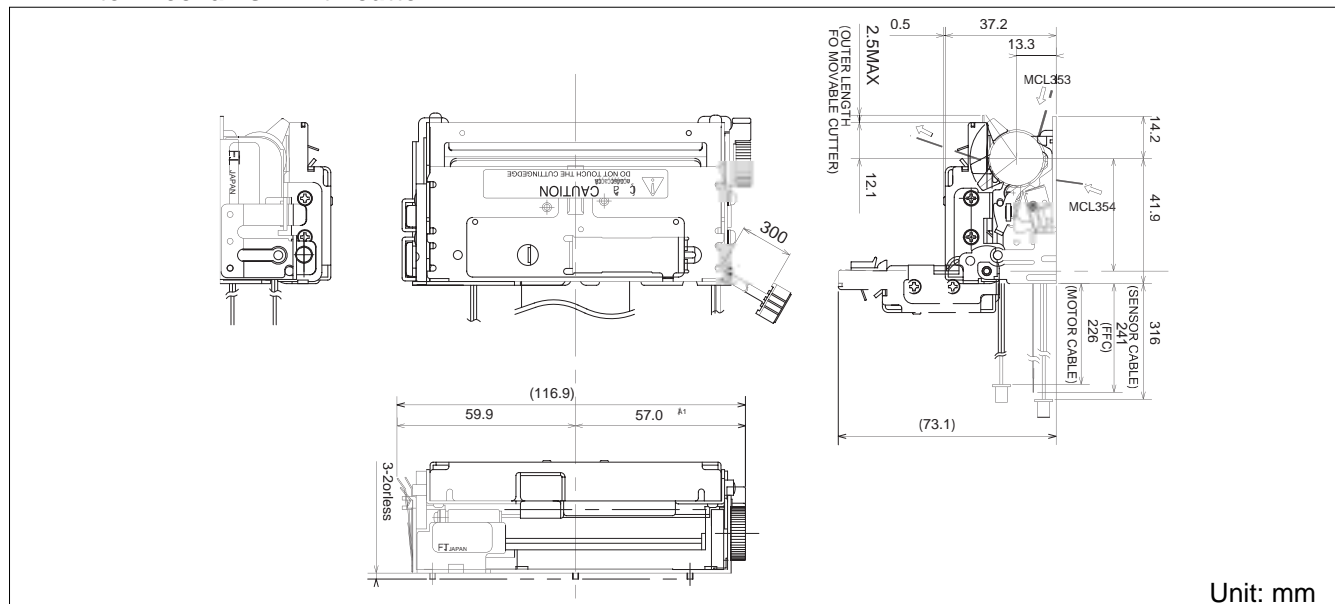

Interface board

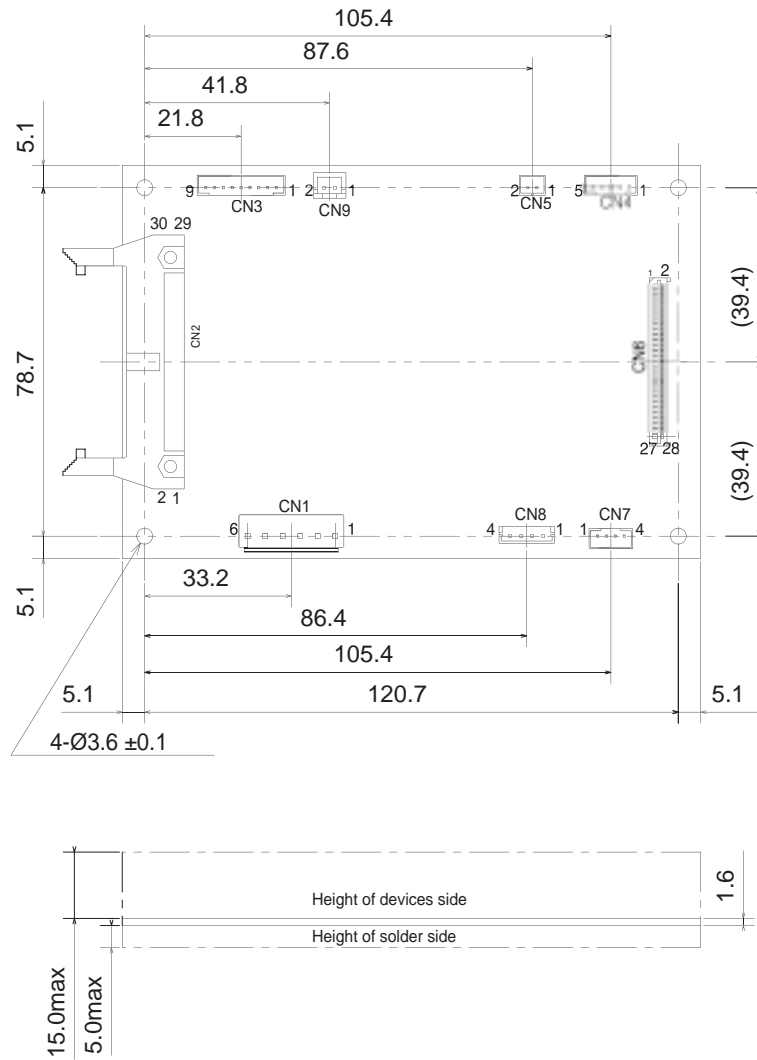

Unit: mm

■ CONNECTOR FOR THERMAL HEAD

1. Thermal Head

Head side : IL-FPC-28CLIP (JAE)

Board side : 52045 (Molex) or equivalent



*1: Symbol: "—" means a negative logic signal

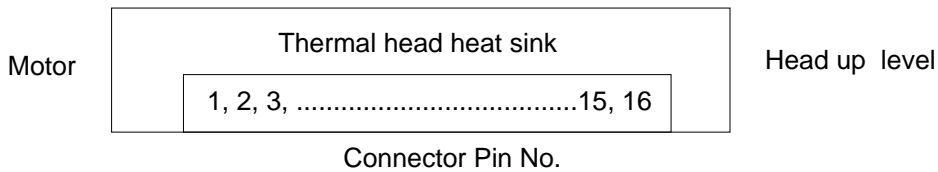

2. Motor connectors

Motor side : PHR-4 (J.S.T.) or equivalent

Board side : B4B-PH-K-S (J.S.T.) or equivalent

No.	Signal	Comment
1	\bar{B}	Pulse motor driving \bar{B}
2	B	Pulse motor driving B
3	\bar{A}	Pulse motor driving \bar{A}
4	A	Pulse motor driving A

No.	Signal	Comment
1	VSEN	Power for paper sensor
2	PHE	Photo interrupter emittor
3	PHK	Photo interrupter cathode
4	SW1	Head up detect switch 1
5	SW2	Head up detect switch 2

3. Cutter

Mech side : EHR-4 (J.S.T.) or equivalent

Board side : B4B-EH (J.S.T.) or equivalent

No	Cable Color	Name
1	White	Home position 1
2	White	Home position 2
3	Red	Motor energizing signal M+
4	Black	Motor energizing signal M-

■ FUNCTION

	ITEM		ITEM
1.	Test printing	8.	Cutter trouble detection
2.	Paper-out detection	9.	Motor power save
3.	Paper near end detection	10.	Mark detection
4.	Head-up detection	11.	MCU trouble detection
5.	Abnormal temp. of thermal head detection	12.	Power on/off sequence protection
6.	Blown fuse detection	13.	Motor protection
7.	Abnormal voltage detection of head	14.	Hardware timer

■ INTERFACE, COMMAND, OPTIONS

Please refer to the FTP-622DCL4xx DATA SHEET and the FTP-622DCL4xx DATA SHEET for Interface, Command, and Options.

Архангельск (8182)63-90-72	Ижевск (3412)26-03-58	Магнитогорск (3519)55-03-13	Пермь (342)205-81-47	Сургут (3462)77-98-35
Астана (7172)727-132	Иркутск (395)279-98-46	Москва (495)268-04-70	Ростов-на-Дону (863)308-18-15	Тверь (4822)63-31-35
Астрахань (8512)99-46-04	Казань (843)206-01-48	Мурманск (8152)59-64-93	Рязань (4912)46-61-64	Томск (3822)98-41-53
Барнаул (3852)73-04-60	Калининград (4012)72-03-81	Набережные Челны (8552)20-53-41	Самара (846)206-03-16	Тула (4872)74-02-29
Белгород (4722)40-23-64	Калуга (4842)92-23-67	Нижний Новгород (831)429-08-12	Санкт-Петербург (812)309-46-40	Тюмень (3452)66-21-18
Брянск (4832)59-03-52	Кемерово (3842)65-04-62	Новокузнецк (3843)20-46-81	Саратов (845)249-38-78	Ульяновск (8422)24-23-59
Владивосток (423)249-28-31	Киров (8332)68-02-04	Новосибирск (383)227-86-73	Севастополь (8692)22-31-93	Уфа (347)229-48-12
Волгоград (844)278-03-48	Краснодар (861)203-40-90	Омск (3812)21-46-40	Симферополь (3652)67-13-56	Хабаровск (4212)92-98-04
Вологда (8172)26-41-59	Красноярск (391)204-63-61	Орел (4862)44-53-42	Смоленск (4812)29-41-54	Челябинск (351)202-03-61
Воронеж (473)204-51-73	Курск (4712)77-13-04	Оренбург (3532)37-68-04	Сочи (862)225-72-31	Череповец (8202)49-02-64
Екатеринбург (343)384-55-89	Липецк (4742)52-20-81	Пенза (8412)22-31-16	Ставрополь (8652)20-65-13	Ярославль (4852)69-52-93
Иваново (4932)77-34-06	Киргизия (996)312-96-26-47	Казахстан (772)734-952-31	Таджикистан (992)427-82-92-69	