

Силовые реле серии FTR-MY Технические характеристики

Архангельск (8182)63-90-72	Ижевск (3412)26-03-58	Магнитогорск (3519)55-03-13	Пермь (342)205-81-47	Сургут (3462)77-98-35
Астана (7172)727-132	Иркутск (395)279-98-46	Москва (495)268-04-70	Ростов-на-Дону (863)308-18-15	Тверь (4822)63-31-35
Астрахань (8512)99-46-04	Казань (843)206-01-48	Мурманск (8152)59-64-93	Рязань (4912)46-61-64	Томск (3822)98-41-53
Барнаул (3852)73-04-60	Калининград (4012)72-03-81	Набережные Челны (8552)20-53-41	Самара (846)206-03-16	Тула (4872)74-02-29
Белгород (4722)40-23-64	Калуга (4842)92-23-67	Нижний Новгород (831)429-08-12	Санкт-Петербург (812)309-46-40	Тюмень (3452)66-21-18
Брянск (4832)59-03-52	Кемерово (3842)65-04-62	Новокузнецк (3843)20-46-81	Саратов (845)249-38-78	Ульяновск (8422)24-23-59
Владивосток (423)249-28-31	Киров (8332)68-02-04	Новосибирск (383)227-86-73	Севастополь (8692)22-31-93	Уфа (347)229-48-12
Волгоград (844)278-03-48	Краснодар (861)203-40-90	Омск (3812)21-46-40	Симферополь (3652)67-13-56	Хабаровск (4212)92-98-04
Вологда (8172)26-41-59	Красноярск (391)204-63-61	Орел (4862)44-53-42	Смоленск (4812)29-41-54	Челябинск (351)202-03-61
Воронеж (473)204-51-73	Курск (4712)77-13-04	Оренбург (3532)37-68-04	Сочи (862)225-72-31	Череповец (8202)49-02-64
Екатеринбург (343)384-55-89	Липецк (4742)52-20-81	Пенза (8412)22-31-16	Ставрополь (8652)20-65-13	Ярославль (4852)69-52-93
Иваново (4932)77-34-06	Киргизия (996)312-96-26-47	Казахстан (772)734-952-31	Таджикистан (992)427-82-92-69	

Единый адрес для всех регионов: fst@nt-rt.ru || www.fujitsu.nt-rt.ru

POWER RELAY

1 POLE - 5A SLIM POWER RELAY

FTR-MY Series

RoHS compliant



FEATURES

- Width 5mm, height 12mm,(31% smaller than NY series) area 100 mm², super slim , low power, compact and light weight 2.5gr.
- Nominal power: 110mW (8% less than NY series), Operate power: 54mW
High sensitive
- High reliability, bifurcated gold overlay silver alloy (cadmium free)
- Complies with IEC 61010, 61131
- Dielectric strength: 3000VAC
- Surge strength: 5080V
- SAFETY STANDARDS
UL, CSA, VDE, CQC
- RoHS Compliant since production
- Plastic sealed type

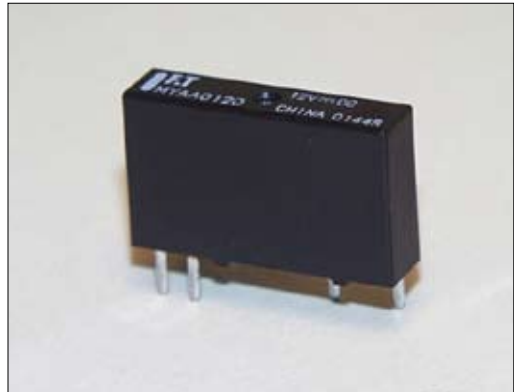

APPLICATIONS

- PLC, I/O module Inverter Control

ORDERING INFORMATION

[Example] $\frac{\text{FTR-MY}}{\text{(a)}} \frac{\text{A}}{\text{(b)}} \frac{\text{A}}{\text{(c)}} \frac{\text{012}}{\text{(d)}} \frac{\text{D}}{\text{(e)}} \frac{\text{- **}}{\text{(f)}}$

(a)	Series Name	FTR-MY Series
(b)	Contact Arrangement	A : 1 Form A
(c)	Coil Type	A : 110 mW
(d)	Coil Nominal Voltage	4.5 : 4.5VDC 012 : 12 VDC 005 : 5 VDC 018 : 18 VDC 006 : 6 VDC 024 : 24 VDC 009 : 9 VDC
(e)	Contact Material	D : Gold overlay Silver alloy
(f)	Custom Designation	Special Number

Note: The designation name is stamped on the top of the relay case as follows:
Example.: Ordering code: FTR-MYAA012D Actual marking: MYAA012D

FTR-MY SERIES

■ COIL DATA CHART

MODEL	Nominal Voltage	Coil Resistance (± 10%)	Must Operate Voltage*	Must Release Voltage*	Nominal Power
FTR-MY Series					
FTR-MYAA4.5D	4.5 VDC	185 Ω	3.15 VDC	0.225 VDC	110 mW
FTR-MYAA005D	5 VDC	230 Ω	3.5 VDC	0.25 VDC	110 mW
FTR-MYAA006D	6 VDC	330 Ω	4.2 VDC	0.3 VDC	110 mW
FTR-MYAA009D	9 VDC	740 Ω	6.3 VDC	0.45 VDC	110 mW
FTR-MYAA012D	12 VDC	1,310 Ω	8.4 VDC	0.6 VDC	110 mW
FTR-MYAA018D	18 VDC	2,950 Ω	12.6 VDC	0.9 VDC	110 mW
FTR-MYAA024D	24 VDC	5,240 Ω	16.8 VDC	1.2 VDC	110 mW

Note: All values in the table are measured at 20°C.

*: Specified values are subject to pulse

■ SPECIFICATIONS

Item		FTR-MY	
Contact	Arrangement	1 form A	
	Material	Gold overlay silver alloy	
	Configuration	Bifurcated (Crossbar)	
	Resistance (initial)	Maximum 30 mΩ (at 1 A 6 VDC)	
	Rating (resistive)	5 A 250 VAC / 5A 30 VDC	
	Maximum Carrying Current	5 A	
	Maximum Switching Rating	1250 VA, 150W	
	Maximum Switching Voltage	277 VAC, 125 VDC	
	Maximum Switching Current	5 A	
	Minimum Switching Load* ¹	5 VDC 1mA	
Coil	Nominal Power (at 20°C)	110 mW	
	Operate Power (at 20°C)	54 mW	
	Operating Temperature	-40°C to +90°C (no frost)	
Time Value	Operate (at nominal voltage)	Maximum 10 ms	
	Release (at nominal voltage)	Maximum 5 ms	
Life	Mechanical	2 x 10 ⁷ operations minimum	
	Electrical	1 × 10 ⁵ operations minimum (at 3A 250VAC, 30VDC resistive) 5 × 10 ⁴ operations minimum (at 5 A 250 VAC, 30 VDC resistive) (switching frequency 20 times/minute)	
Other	Vibration Resistance	Misoperation	10 to 55 Hz (double amplitude of 1.5 mm)
		Endurance	10 to 55 Hz (double amplitude of 1.5 mm)
	Shock Resistance	Misoperation	100 m/s ² (11 ± 1 ms)
		Endurance	1,000 m/s ² (6 ± 1 ms)
	Weight	Approximately 2.5 g	

*¹ Minimum switching loads mentioned above are reference values. Please perform the confirmation test with the actual load before production since reference values may vary according to switching frequencies, environmental conditions and expected reliability levels.

FTR-MY SERIES

■ INSULATION

Item	FTR-MY	Note
Resistance (initial)	Minimum 1,000 MΩ	at 500 VDC
Dielectric Strength	open contacts	750 VAC 1 min.
	coil and contacts	3,000 VAC 1 min.
Surge Voltage	5,080 V	1.2 x 50μs standard wave

■ SAFETY STANDARDS

Type	Compliance	Contact rating
UL	UL 508, UL 1604	Flammability: UL 94-V0 (plastics) 5A, 277 VAC (resistive) 5A, 30 VDC (resistive)
	E63614, E225300	
CSA	C22.2 No. 14 LR 40304	1/10 HP, 277VAC /125VAC Pilot duty: D300, C300, R300

FTR-MY SERIES

REFERENCE DATA

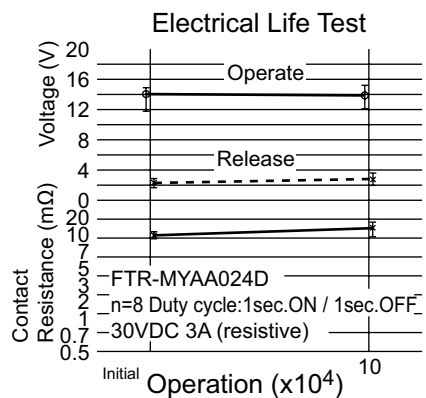
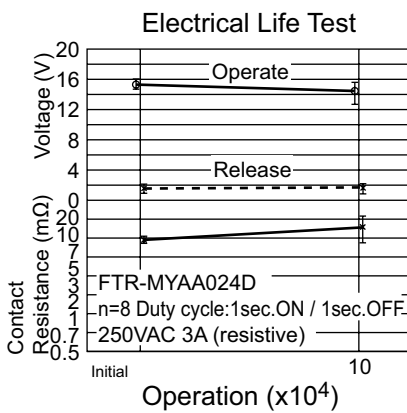
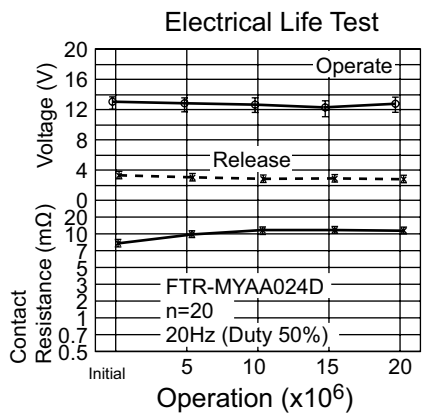
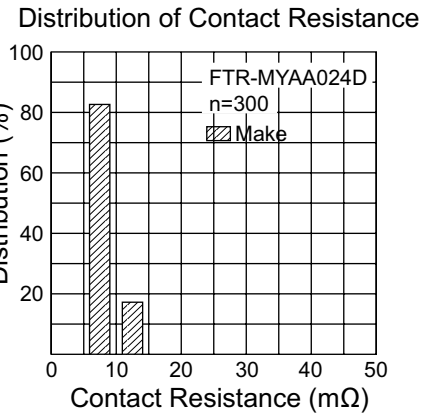
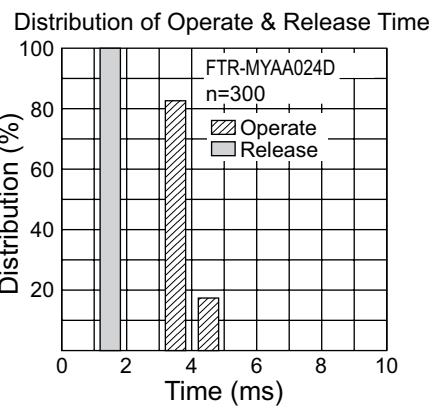
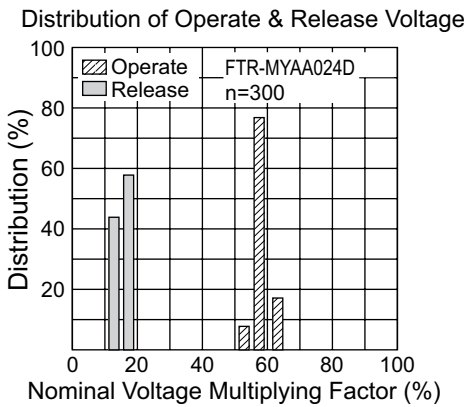
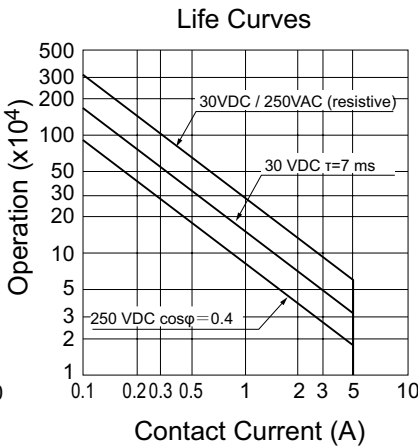
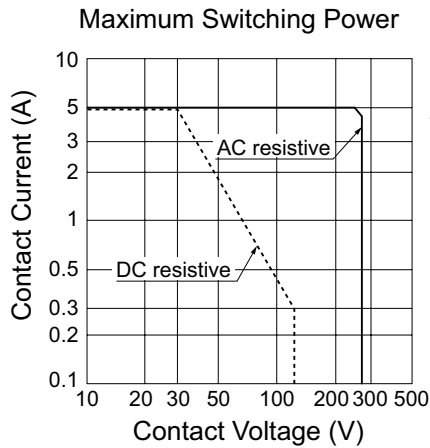
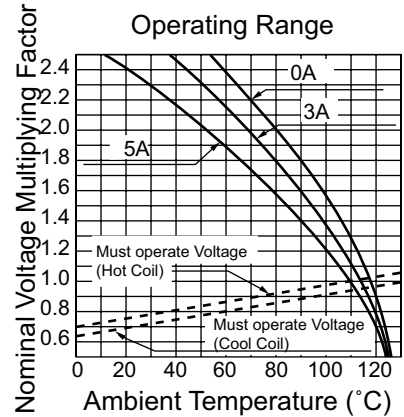
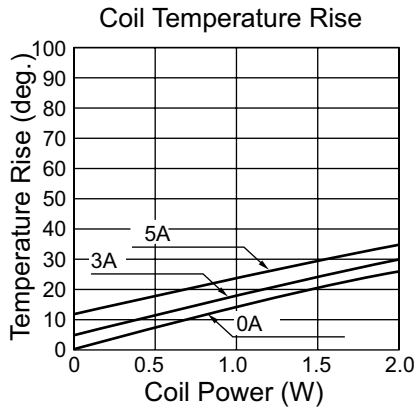
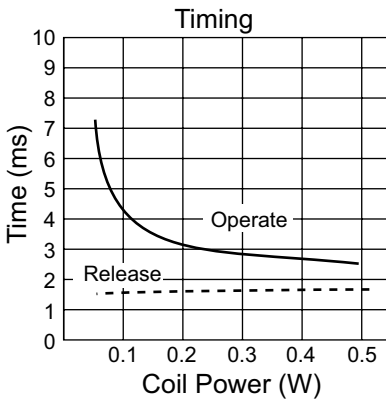

FTR-MY SERIES

■ DIMENSIONS

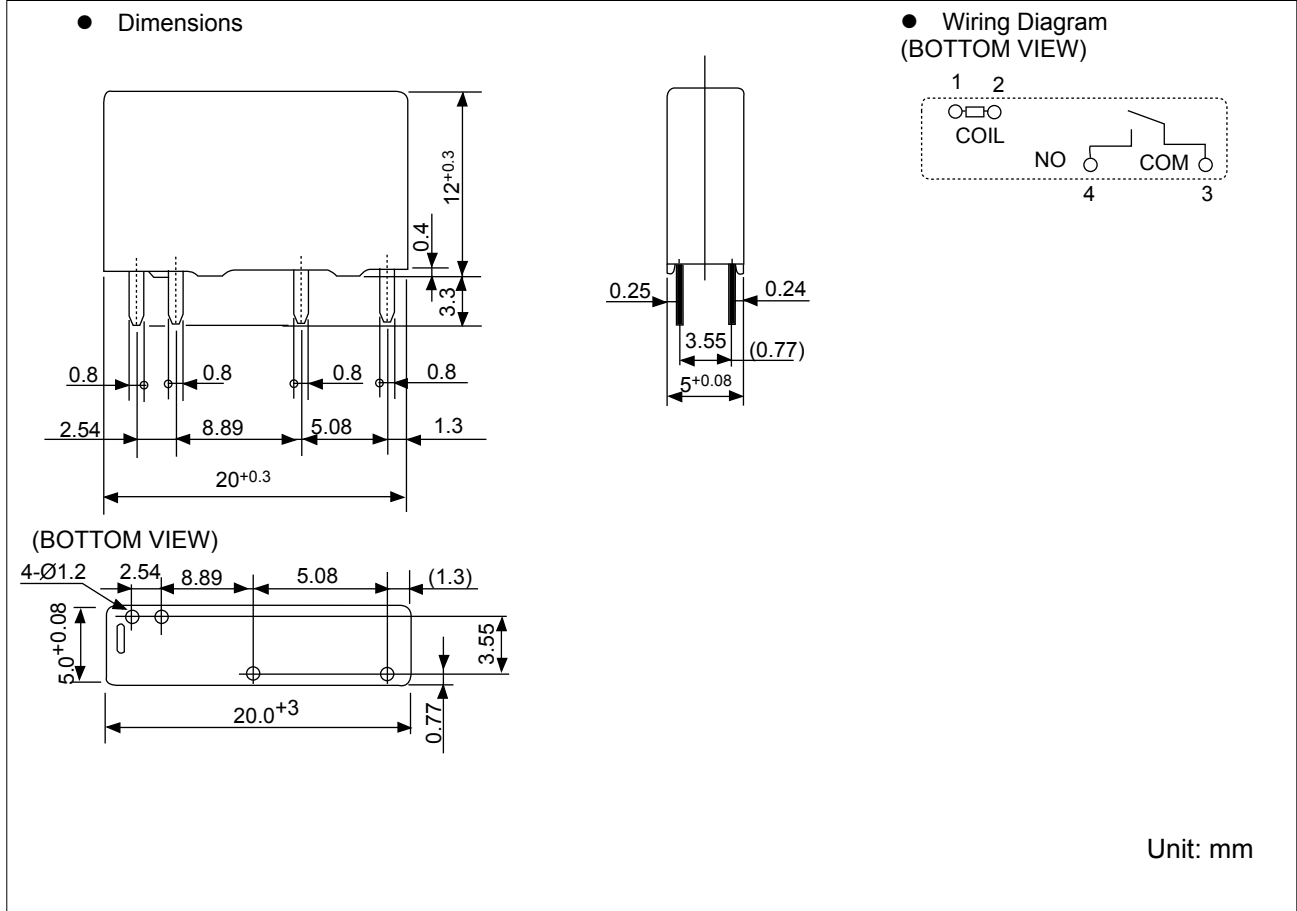

RoHS Compliance and Lead Free Relay Information

1. General Information

- Relays produced after the specific date code that is indicated on each data sheet are lead-free now. All of our signal and power relays are lead-free. Please refer to Lead-Free Status Info.
- Lead free solder paste currently used in relays is Sn-3.0Ag-0.5Cu.
- All signal and power relays also comply with RoHS. Please refer to individual data sheets. Relays that are RoHS compliant do not contain the 5 hazardous materials that are restricted by RoHS directive (lead, mercury, chromium IV, PBB, PBDE).
- It has been verified that using lead-free relays in leaded assembly process will not cause any problems (compatible).
- "LF" is marked on each outer and inner carton. (No marking on individual relays).
- To avoid leaded relays (for lead-free sample, etc.) please consult with area sales office.
- We will ship leaded relays as long as the leaded relay inventory exists.

Note: Cadmium was exempted from RoHS on October 21, 2005. (Amendment to Directive 2002/95/EC)

2. Recommended Lead Free Solder Profile

- Recommended solder paste Sn-3.0Ag-0.5Cu.

Reflow Solder condition

Flow Solder condition:

Pre-heating: maximum 120°C
Soldering: dip within 5 sec. at
260°C solder bath

Solder by Soldering Iron:

Soldering Iron
Temperature: maximum 360°C
Duration: maximum 3 sec.

We highly recommend that you confirm your actual solder conditions

3. Moisture Sensitivity

- Moisture Sensitivity Level standard is not applicable to electromechanical relays.

4. Tin Whisker

- Dipped SnAgCu solder is known as low risk tin whisker. No considerable length whisker was found by our in house test.

Архангельск (8182)63-90-72	Ижевск (3412)26-03-58	Магнитогорск (3519)55-03-13	Пермь (342)205-81-47	Сургут (3462)77-98-35
Астана (7172)727-132	Иркутск (395)279-98-46	Москва (495)268-04-70	Ростов-на-Дону (863)308-18-15	Тверь (4822)63-31-35
Астрахань (8512)99-46-04	Казань (843)206-01-48	Мурманск (8152)59-64-93	Рязань (4912)46-61-64	Томск (3822)98-41-53
Барнаул (3852)73-04-60	Калининград (4012)72-03-81	Набережные Челны (8552)20-53-41	Самара (846)206-03-16	Тула (4872)74-02-29
Белгород (4722)40-23-64	Калуга (4842)92-23-67	Нижний Новгород (831)429-08-12	Санкт-Петербург (812)309-46-40	Тюмень (3452)66-21-18
Брянск (4832)59-03-52	Кемерово (3842)65-04-62	Новокузнецк (3843)20-46-81	Саратов (845)249-38-78	Ульяновск (8422)24-23-59
Владивосток (423)249-28-31	Киров (8332)68-02-04	Новосибирск (383)227-86-73	Севастополь (8692)22-31-93	Уфа (347)229-48-12
Волгоград (844)278-03-48	Краснодар (861)203-40-90	Омск (3812)21-46-40	Симферополь (3652)67-13-56	Хабаровск (4212)92-98-04
Вологда (8172)26-41-59	Красноярск (391)204-63-61	Орел (4862)44-53-42	Смоленск (4812)29-41-54	Челябинск (351)202-03-61
Воронеж (473)204-51-73	Курск (4712)77-13-04	Оренбург (3532)37-68-04	Сочи (862)225-72-31	Череповец (8202)49-02-64
Екатеринбург (343)384-55-89	Липецк (4742)52-20-81	Пенза (8412)22-31-16	Ставрополь (8652)20-65-13	Ярославль (4852)69-52-93
Иваново (4932)77-34-06	Киргизия (996)312-96-26-47	Казахстан (772)734-952-31	Таджикистан (992)427-82-92-69	

Единый адрес для всех регионов: fst@nt-rt.ru || www.fujitsu.nt-rt.ru