

## Силовые реле серии JS

### Технические характеристики

Архангельск (8182)63-90-72	Ижевск (3412)26-03-58	Магнитогорск (3519)55-03-13	Пермь (342)205-81-47	Сургут (3462)77-98-35
Астана (7172)727-132	Иркутск (395)279-98-46	Москва (495)268-04-70	Ростов-на-Дону (863)308-18-15	Тверь (4822)63-31-35
Астрахань (8512)99-46-04	Казань (843)206-01-48	Мурманск (8152)59-64-93	Рязань (4912)46-61-64	Томск (3822)98-41-53
Барнаул (3852)73-04-60	Калининград (4012)72-03-81	Набережные Челны (8552)20-53-41	Самара (846)206-03-16	Тула (4872)74-02-29
Белгород (4722)40-23-64	Калуга (4842)92-23-67	Нижний Новгород (831)429-08-12	Санкт-Петербург (812)309-46-40	Тюмень (3452)66-21-18
Брянск (4832)59-03-52	Кемерово (3842)65-04-62	Новокузнецк (3843)20-46-81	Саратов (845)249-38-78	Ульяновск (8422)24-23-59
Владивосток (423)249-28-31	Киров (8332)68-02-04	Новосибирск (383)227-86-73	Севастополь (8692)22-31-93	Уфа (347)229-48-12
Волгоград (844)278-03-48	Краснодар (861)203-40-90	Омск (3812)21-46-40	Симферополь (3652)67-13-56	Хабаровск (4212)92-98-04
Вологда (8172)26-41-59	Красноярск (391)204-63-61	Орел (4862)44-53-42	Смоленск (4812)29-41-54	Челябинск (351)202-03-61
Воронеж (473)204-51-73	Курск (4712)77-13-04	Оренбург (3532)37-68-04	Сочи (862)225-72-31	Череповец (8202)49-02-64
Екатеринбург (343)384-55-89	Липецк (4742)52-20-81	Пенза (8412)22-31-16	Ставрополь (8652)20-65-13	Ярославль (4852)69-52-93
Иваново (4932)77-34-06	Киргизия (996)312-96-26-47	Казахстан (772)734-952-31	Таджикистан (992)427-82-92-69	

Единый адрес для всех регионов: [fst@nt-rt.ru](mailto:fst@nt-rt.ru) || [www.fujitsu.nt-rt.ru](http://www.fujitsu.nt-rt.ru)

# POWER RELAY

## 1 POLE—8 A (MEDIUM LOAD CONTROL)

### JS SERIES

#### ■ FEATURES

- UL, CSA, VDE, SEV, SEMKO, FIMKO, ÖVE, BSI recognized
- UL class B (130°C) insulation
- 1 form A (SPST-NO) or 1 form C (SPDT) contact
- Low profile and space saving—Height: 12.5 mm  
—Mounting space: 290 mm<sup>2</sup>
- High sensitivity in small package  
—Operating power ..... 0.11 to 0.14 W  
—Nominal power ..... 0.22 to 0.29 W
- High isolation in small package  
—Insulation distance : 8 mm  
—Dielectric strength : 5,000 VAC (between coil and contacts)  
—Surge strength : 10,000 V
- Plastic materials—UL 94 flame class V-0  
—UL CTI level class 2
- Plastic sealed type
- Lead Free since date code: 0438B9, 0434R  
Please see page 6 for more information



#### ■ ORDERING INFORMATION

[Example]      JS - 12 M E - K T - (V3)  
                  (a) (\*) (b) (c) (d) (e) (f) (j)

(a)	Series Name	JS : JS Series
(b)	Nominal Voltage	Refer to the COIL DATA CHART
(c)	Contact Arrangement	Nil : 1 form C (SPDT) M : 1 form A (SPST-NO)
(d)	Contact Material	Nil : Gold plate (0.3μ) silver cadmium oxide D : Silver nickel E : Silver cadmium oxide F : Silver nickel gold overlay (with "-3V" only) N : Silver tin oxide gold overlay (0.3μ)
(e)	Enclosure	K : Plastic sealed type
(f)	Construction	Nil : 3.2 mm T : 5.0 mm (only JS-MN)
(j)	For low current application	V3 : For low current applications (3μ gold overlay) * not available with "E" contact material * not available with "T" construction

Note: Actual marking omits the hyphen (-) of (\*)

## ■ SAFETY STANDARD AND FILE NUMBERS

UL508, 873 (File No. E56140, E108658)

C22.2 No. 14 (File No. LR35579)

VDE 0435, 0631, 0700 (File No. 11039-4940-1010)

Nominal voltage	Contact rating
5 to 60 VDC	1/3 HP 125 VAC, 1/2 HP 250 VAC 10 A 30 VDC/250 VAC, resistive 3A 250 VAC inductive (PF = 0.4) Pilot duty B 300, C150

## ■ SPECIFICATIONS

Item		JS	
		Gold overlay silver alloy (standard) silver alloy	Gold overlay silver alloy (-V3)
Contact	Arrangement	1 form A (SPST-NO), 1 form C (SPDT)	
	Material	Gold plate silver cadmium oxide / cadmium oxide / silver tin oxide gold overlay / silver nickel	Gold overlay silver cadmium oxide / Gold overlay silver tin oxide / Gold overlay silver nickel
	Style	Single	
	Resistance (initial)	Maximum 100 mΩ (at 1 A 6 VDC)	maximum 30 mΩ
	Rating (resistive)	8 A 250 VAC or 8 A 24 VDC	
	Maximum Carrying Current	10 A	
	Maximum Switching Power	2,000 VA, 192 W	
	Maximum Switching Voltage	400VAC, 250 VDC	
	Maximum Switching Current	10 A	
	Minimum Switching Load*1	100 mA 5 VDC	10 mA 5 VDC
Coil	Nominal Power (at 20°C)	0.22 to 0.29 W	
	Operate Power (at 20°C)	0.11 to 0.14 W	
	Operating Temperature	-40°C to +85°C (no frost)	
Time Value	Operate (at nominal voltage)	Maximum 10 ms	
	Release (at nominal voltage)	Maximum 5 ms	
Insulation	Resistance (at 500 VDC)	Minimum 1,000 MΩ	
	Dielectric Strength	between open contacts	1,000 VAC 1 minute
		between coil and contacts	5,000 VAC 1 minute
Surge Strength	10,000 V (at 1.2 × 50 μs)		
Life	Mechanical	2 × 10 <sup>7</sup> operations minimum	
	Electrical	1 × 10 <sup>5</sup> operations minimum (D, F contact: 20 × 10 <sup>3</sup> ops. min.) (nominal load)	
Other	Vibration Resistance	Misoperation	10 to 55 Hz (double amplitude of 1.65 mm)
		Endurance	10 to 55 Hz (double amplitude of 3.3 mm)
	Shock Resistance	Misoperation	100 m/s <sup>2</sup> (11 ±1 ms)
		Endurance	1,000 m/s <sup>2</sup> (6 ±1 ms)
Weight	Approximately 8 g		

\*1 Minimum switching loads mentioned above are reference values. Please perform the confirmation test with the actual load before production since reference values may vary according to switching frequencies, environmental conditions and expected reliability levels.

## COIL DATA CHART

MODEL	Nominal voltage	Coil resistance ( $\pm 10\%$ )	Must operate voltage	Must release voltage	Nominal power
JS- 5 (M) (E, N) -K (T)	5 VDC	112 $\Omega$	3.5 VDC	0.5 VDC	225 mW
JS- 6 (M) (E, N) -K (T)	6 VDC	160 $\Omega$	4.2 VDC	0.6 VDC	225 mW
JS- 9 (M) (E, N) -K (T)	9 VDC	360 $\Omega$	6.3 VDC	0.9 VDC	225 mW
JS-12 (M) (E, N) -K (T)	12 VDC	660 $\Omega$	8.5 VDC	1.2 VDC	220 mW
JS-18 (M) (E, N) -K (T)	18 VDC	1,455 $\Omega$	12.7 VDC	1.8 VDC	225 mW
JS-24 (M) (E, N) -K (T)	24 VDC	2,350 $\Omega$	16.8 VDC	2.4 VDC	245 mW
JS-48 (M) (E, N) -K (T)	48 VDC	8,000 $\Omega$	33.4 VDC	4.8 VDC	290 mW
JS-60 (M) (E, N) -K (T)	60 VDC	12,500 $\Omega$	41.7 VDC	6.0 VDC	290 mW

Note : All values in the table are measured at 20°C.

## CHARACTERISTIC DATA

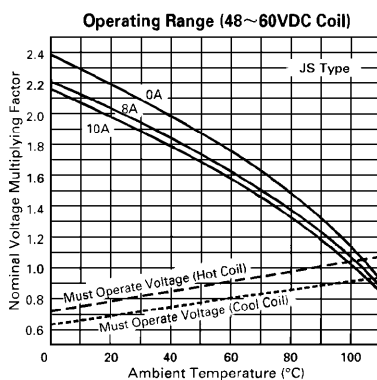
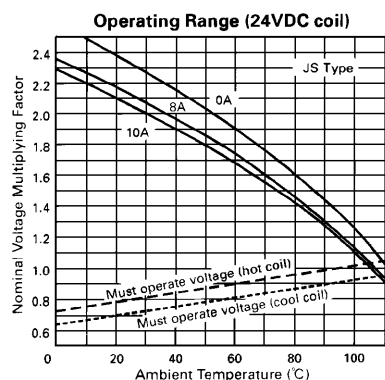
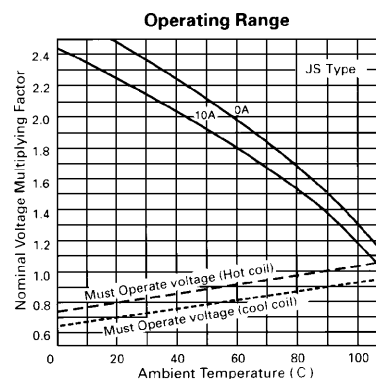
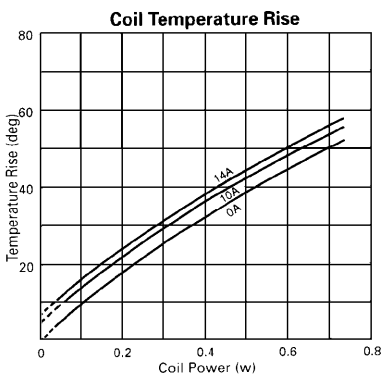
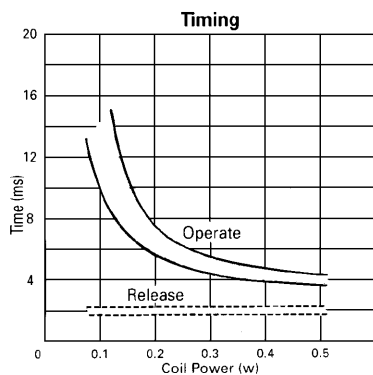

## Maximum Switching Power

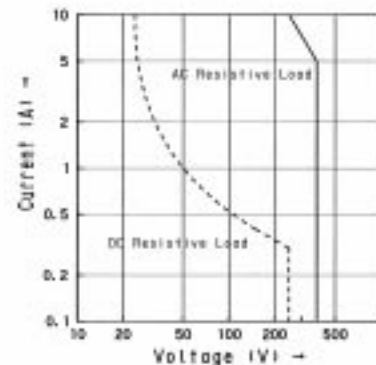

## Life Curves

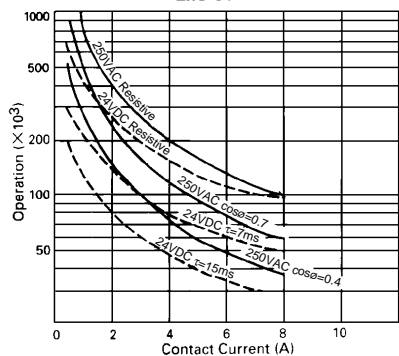

## REFERENCE DATA

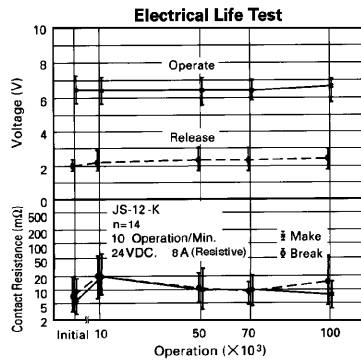
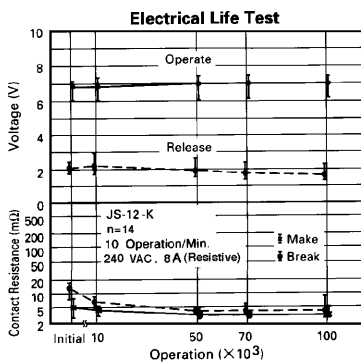
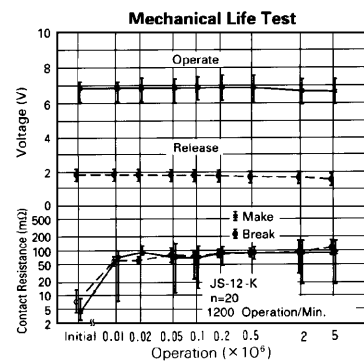
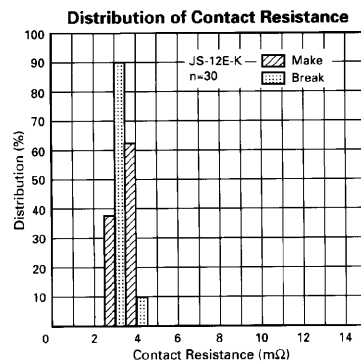
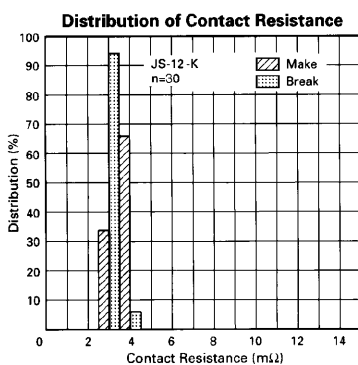
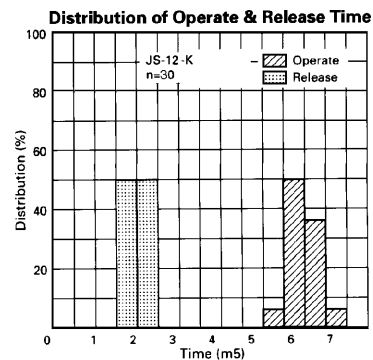
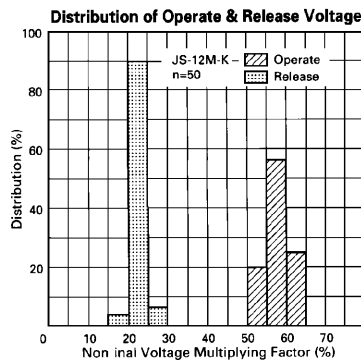
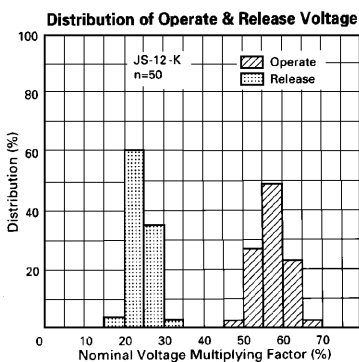

## ■ DIMENSIONS

### ● Dimensions

#### JS-MK type

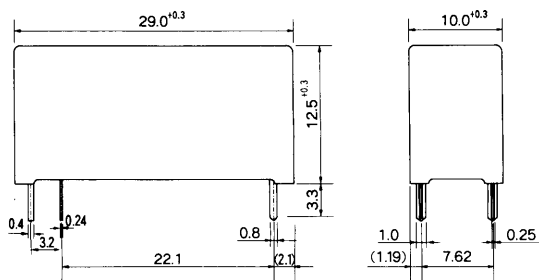

### ● Schematics (BOTTOM VIEW)

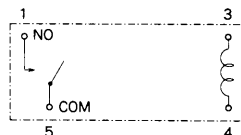

### ● PC board mounting hole layout (BOTTOM VIEW)

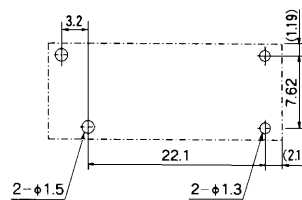

#### JS-K type

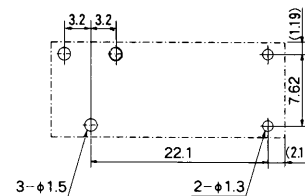
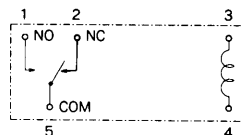
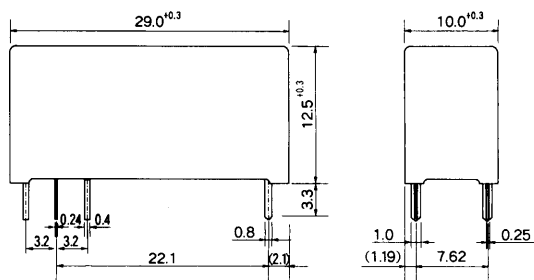

#### JS-MN-KT type

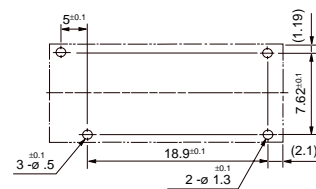
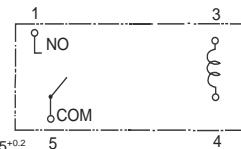
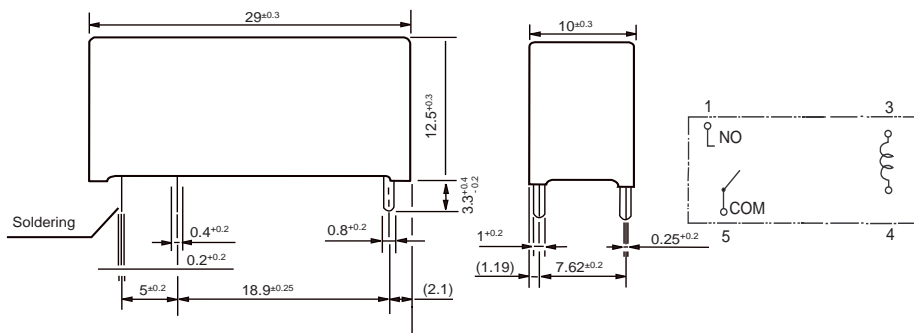

Unit: mm

## RoHS Compliance and Lead Free Relay Information

### 1. General Information

- Relays produced after the specific date code that is indicated on each data sheet are lead-free now. Most of our signal and power relays are lead-free.
- Lead free solder paste currently used in relays is Sn-3.0Ag-0.5Cu. From February 2005 forward Sn-3.0Cu-Ni will be used for FTRB3 and FTR-B4 series relays.
- Most signal and some power relays also comply with RoHS. Please refer to individual data sheets. Relays that are RoHS compliant do not contain the 6 hazardous materials that are restricted by RoHS directive (lead, mercury, cadmium, chromium IV, PBB, PBDE).
- It has been verified that using lead-free relays in lead assembly process will not cause any problems (compatible).
- "LF" is marked on each outer and inner carton. (No marking on individual relays).
- To avoid leaded relays (for lead-free sample, etc.) please consult with area sales office. We will ship leaded relays as long as the leaded relay inventory exists.

### 2. Recommended Lead Free Solder Profile

- Recommended solder paste Sn-3.0Ag-0.5Cu and Sn-3.0 Cu-Ni (only FTR-B3 and FTR-B4 from February 2005)

#### Reflow Solder condition

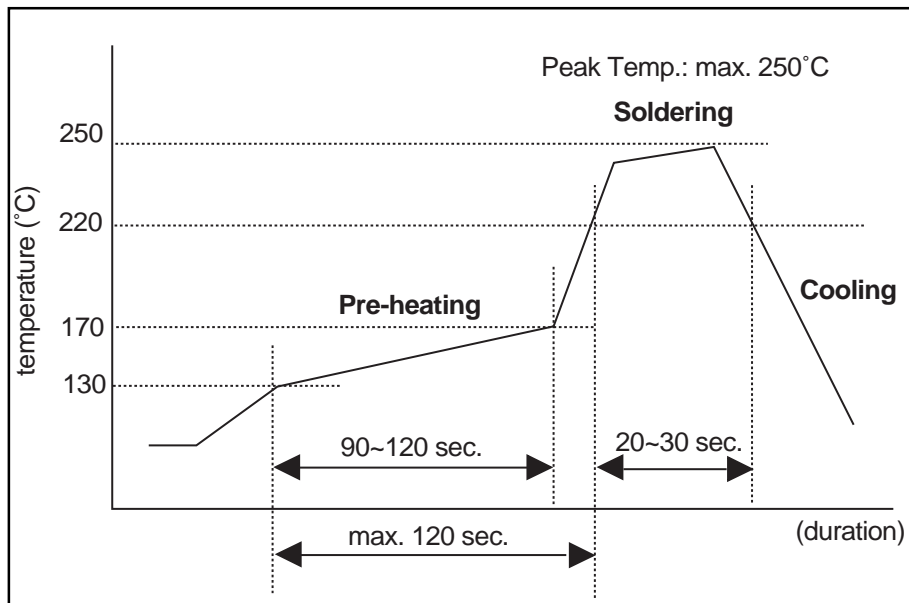

#### Flow Solder condition:

Pre-heating: maximum 120°C  
Soldering: dip within 5 sec. at 260°C solder bath

#### Solder by Soldering Iron:

Soldering Iron  
Temperature: maximum 360°C  
Duration: maximum 3 sec.

**We highly recommend that you confirm your actual solder conditions**

### 3. Moisture Sensitivity

- Moisture Sensitivity Level standard is not applicable to electromechanical relays.

### 4. Tin Whisker

- SnAgCu solder is known as low risk of tin whisker. No considerable length whisker was found by our in-house test.

### 5. Solid State Relays

- Each lead terminal will be changed from solder plating to Sn plating and Nickel plating. A layer of Nickel plating is between the terminal and the Sn plating to avoid whisker.

<b>Архангельск (8182)63-90-72</b>	<b>Ижевск (3412)26-03-58</b>	<b>Магнитогорск (3519)55-03-13</b>	<b>Пермь (342)205-81-47</b>	<b>Сургут (3462)77-98-35</b>
<b>Астана (7172)727-132</b>	<b>Иркутск (395)279-98-46</b>	<b>Москва (495)268-04-70</b>	<b>Ростов-на-Дону (863)308-18-15</b>	<b>Тверь (4822)63-31-35</b>
<b>Астрахань (8512)99-46-04</b>	<b>Казань (843)206-01-48</b>	<b>Мурманск (8152)59-64-93</b>	<b>Рязань (4912)46-61-64</b>	<b>Томск (3822)98-41-53</b>
<b>Барнаул (3852)73-04-60</b>	<b>Калининград (4012)72-03-81</b>	<b>Набережные Челны (8552)20-53-41</b>	<b>Самара (846)206-03-16</b>	<b>Тула (4872)74-02-29</b>
<b>Белгород (4722)40-23-64</b>	<b>Калуга (4842)92-23-67</b>	<b>Нижний Новгород (831)429-08-12</b>	<b>Санкт-Петербург (812)309-46-40</b>	<b>Тюмень (3452)66-21-18</b>
<b>Брянск (4832)59-03-52</b>	<b>Кемерово (3842)65-04-62</b>	<b>Новокузнецк (3843)20-46-81</b>	<b>Саратов (845)249-38-78</b>	<b>Ульяновск (8422)24-23-59</b>
<b>Владивосток (423)249-28-31</b>	<b>Киров (8332)68-02-04</b>	<b>Новосибирск (383)227-86-73</b>	<b>Севастополь (8692)22-31-93</b>	<b>Уфа (347)229-48-12</b>
<b>Волгоград (844)278-03-48</b>	<b>Краснодар (861)203-40-90</b>	<b>Омск (3812)21-46-40</b>	<b>Симферополь (3652)67-13-56</b>	<b>Хабаровск (4212)92-98-04</b>
<b>Вологда (8172)26-41-59</b>	<b>Красноярск (391)204-63-61</b>	<b>Орел (4862)44-53-42</b>	<b>Смоленск (4812)29-41-54</b>	<b>Челябинск (351)202-03-61</b>
<b>Воронеж (473)204-51-73</b>	<b>Курск (4712)77-13-04</b>	<b>Оренбург (3532)37-68-04</b>	<b>Сочи (862)225-72-31</b>	<b>Череповец (8202)49-02-64</b>
<b>Екатеринбург (343)384-55-89</b>	<b>Липецк (4742)52-20-81</b>	<b>Пенза (8412)22-31-16</b>	<b>Ставрополь (8652)20-65-13</b>	<b>Ярославль (4852)69-52-93</b>
<b>Иваново (4932)77-34-06</b>	<b>Киргизия (996)312-96-26-47</b>	<b>Казахстан (772)734-952-31</b>	<b>Таджикистан (992)427-82-92-69</b>	

Единый адрес для всех регионов: [fst@nt-rt.ru](mailto:fst@nt-rt.ru) || [www.fujitsu.nt-rt.ru](http://www.fujitsu.nt-rt.ru)